



# GEARGRID Seattle / SCUBA Storage System

Assembly Instructions & Owners Manual

Thank you for choosing the Geargrid Seattle / SCUBA Storage System. Geargrid is committed to high-quality products and your complete satisfaction.

Please read this manual before you start the assembly. Call us at 888-643-6694 if you need technical assistance or encounter product performance questions along the way.

## Before You Begin:

**NOTE:** Two person assembly is required

## Assembly Preparation:

- Open and remove contents from all boxes
- Check all parts against the parts list
- Organize parts by type
- Locate a clear, level floor
- Lay the shipping carton cardboard on the floor and assemble the unit on it for protection during assembly.

## Tools Required:

- Rubber mallet
- 3/8", 7/16", and 9/16" sockets with ratchet
- 1/4" and 5/32" Hex Allen wrench



**THANK YOU FOR CHOOSING GEARGRID** for smarter, stronger, storage solutions.  
Setting the standard for craftsmanship, quality and service.

**For general parts or assembly assistance:** 651-464-4468 or toll free 888-643-6694

**For accessory inquiries:** sales@geargrid.com or 651-464-4468, toll free 888-643-6694

**For our versatile product line, specifications and resources for custom solutions:** www.geargridcorp.com

670 SW 15th Street, Forest Lake, MN 55025 | Toll Free: 888-643-6694 | 651-464-4468 | Fax: 651-464-4780  
sales@GearGrid.com | www.geargridcorp.com

# Parts

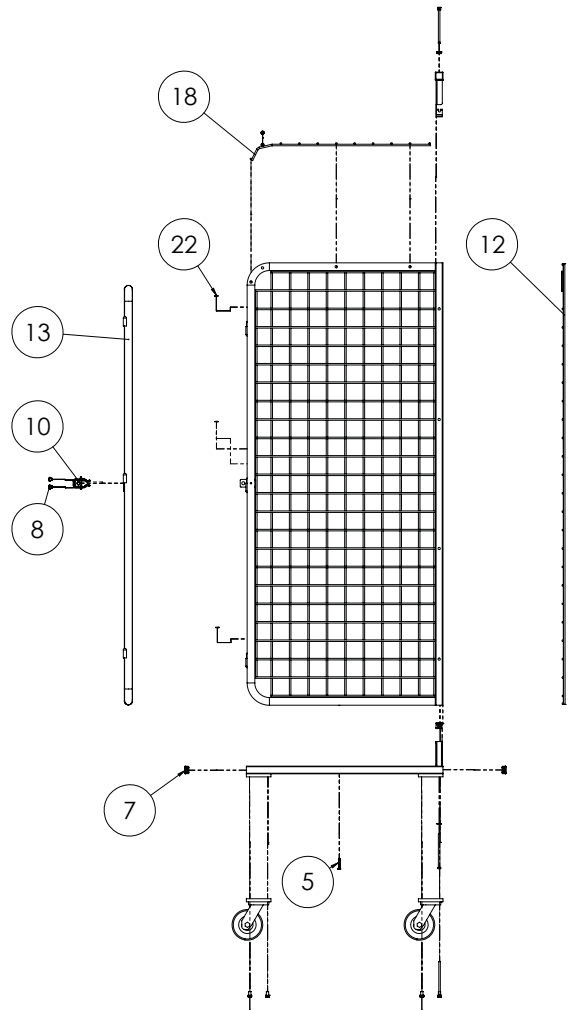
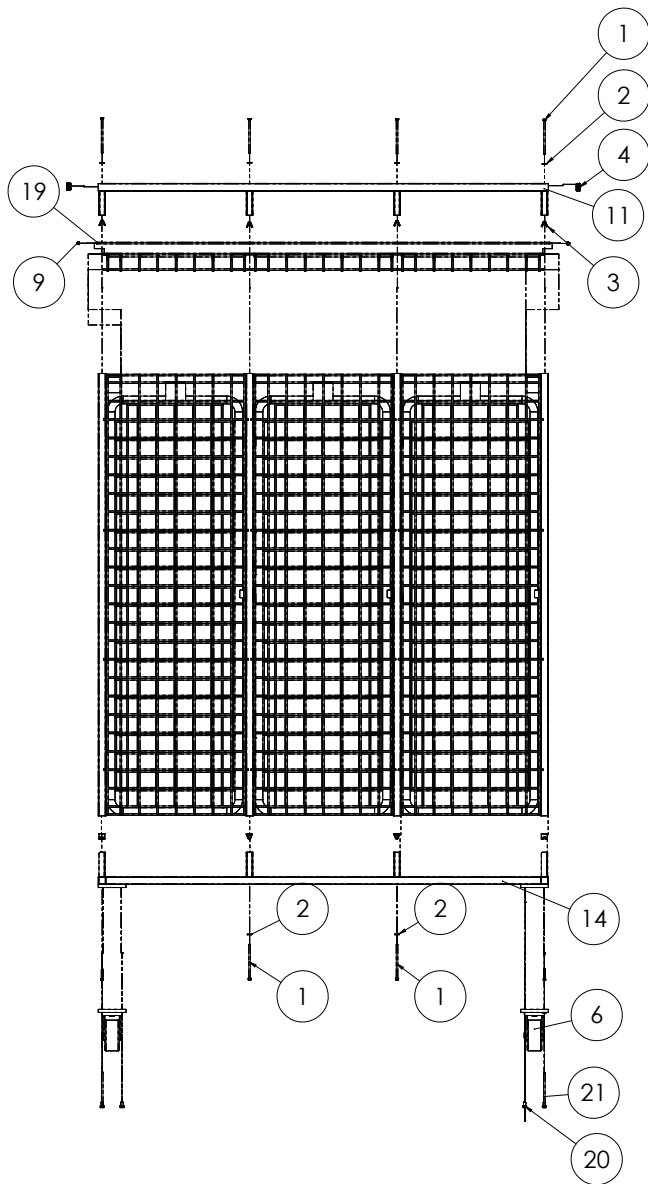

① 1/4-20 x 5-1/2" BOLT  
QTY - 6



⑤ SCREW, #14  
QTY - 4



⑨ 1/4-20 ACORN NUT  
QTY - 2



② 1/4" WASHER  
QTY - 8



⑥ CASTER  
QTY - 4

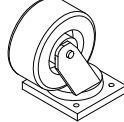

⑩ DOOR LATCH ASSEMBLY  
QTY - 3  
PER DOOR  
ORDER



③ WEDGE NUT  
QTY - 8



⑦ PLUG, 11 GAUGE  
QTY - 4



④ PLUG, 16 GAUGE  
QTY - 2

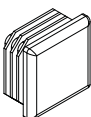

⑧ 1/4-20 x 3/8" SCREW  
QTY - 6  
PER DOOR ORDER



# Parts

- ① 3-START  
QTY - 1



- ② BACK PANEL  
QTY - 3

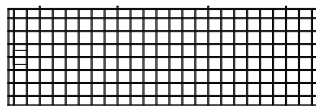

- ③ DOOR  
QTY - 3  
PER DOOR ORDER

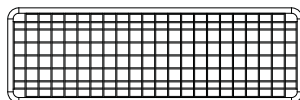

- ④ BASE 3-PACK  
QTY - 1

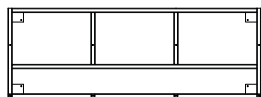

- ⑤ SIDE, HINGE / HASP  
QTY - 2  
PER DOOR ORDER

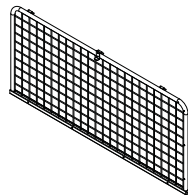

- ⑥ SIDE, HINGE  
QTY - 1  
PER DOOR ORDER

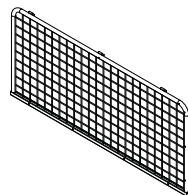

- ⑦ SIDE, HASP  
QTY - 1  
PER DOOR ORDER

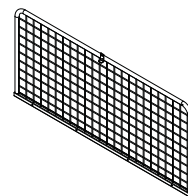

- ⑧ TOP  
QTY - 3

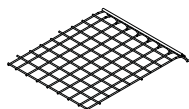

- ⑨ 1/4-20 STAINLESS STEEL ROD  
QTY - 1

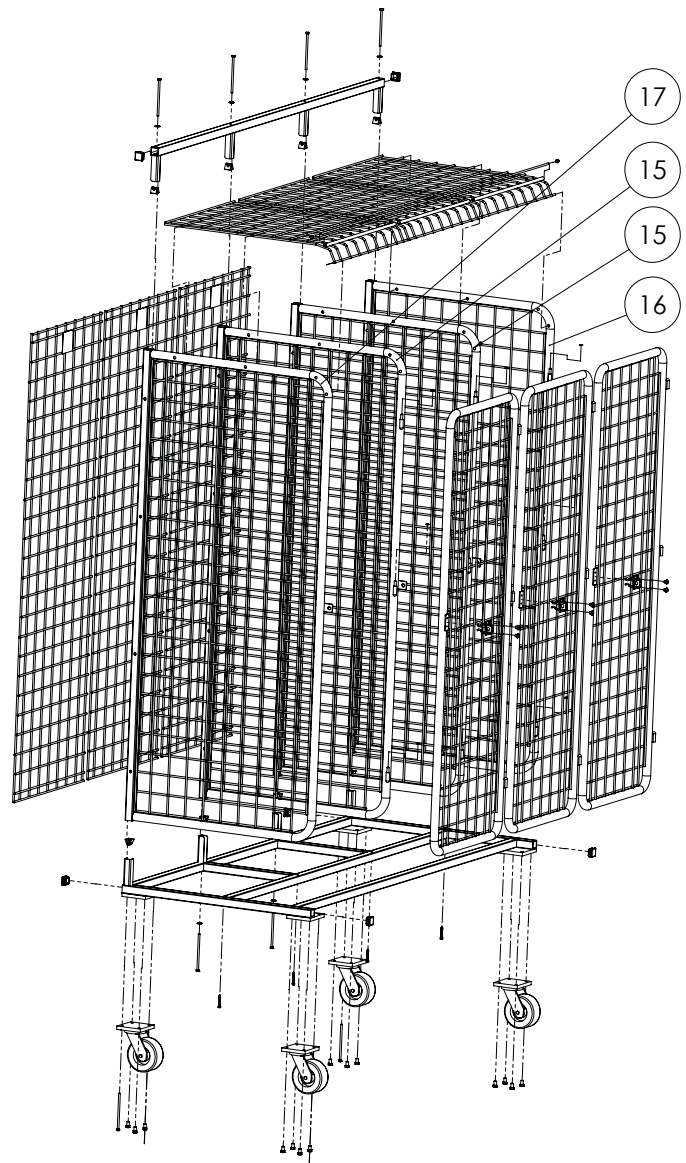
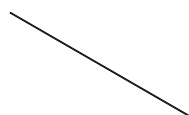

- ⑩ 3/8-16 x 5/8" BOLT  
QTY - 14



- ⑪ 1/4-20 x 6-1/2" BOLT  
QTY - 2

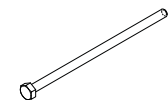

- ⑫ HINGE, BRASS BUSHING  
QTY - 9  
PER DOOR ORDER



- ⑬ SIDE, STANDARD  
QTY - 4

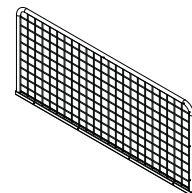

# Base Unit Assembly

**Step 1:** Locate the following parts from the list:

Part	Description	Quantity
#14	Base, 3 Pack	1
#6	Caster	4
#2	1/4" Washer	2
#20	3/8-16 x 5/8" Bolt	14
#21	1/4-20 x 6-1/2" Bolt	2

Begin by setting the base in position shown in the photo below. Install the casters using the bolts noted above. Ensure the two long bolts with washers are positioned as shown in the photo below. **Tighten all bolts except the two long bolts.**

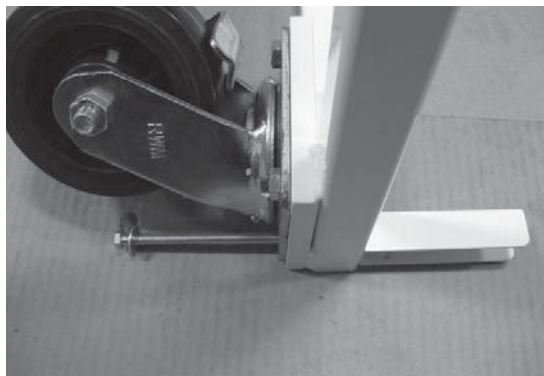
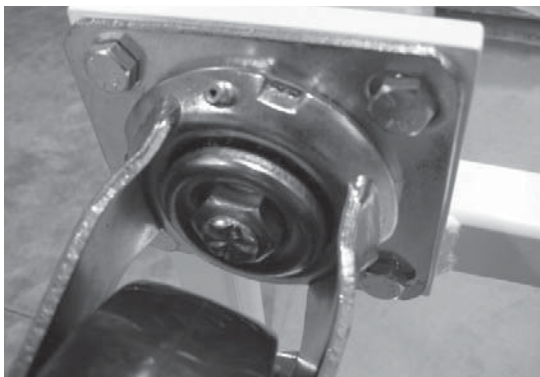

**Step 2:** Locate the following parts from the list:

Part	Description	Quantity
#3	Wedge Nut	4
#1	1/4-20 x 5-1/2" Bolt	2
#2	1/4" Washer	2

Install wedge nuts on the two longer bolts that were installed in step 1. Ensure the orientation is as shown in the photo below. Install the 1/4-20 x 5-1/2" bolts, washers and wedge nuts to the center U-channels on the base. **Do not tighten these bolts at this time.**

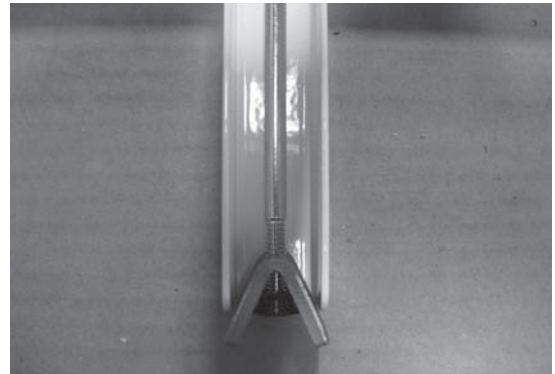

## Base Unit Assembly (cont.)

**Step 3:** Locate the following parts from the list:

Part	Description	Quantity
#11	3-Start	1
#1	1/4-20 x 5-1/2" Bolt	4
#2	1/4" Washer	4
#3	Wedge Nut	4

Install bolts, washers and wedge nuts to the 3-start as shown in the photos below. Ensure the orientation of the wedge nut is as shown. Set assembly aside.

**Do not tighten the bolts at this time.**

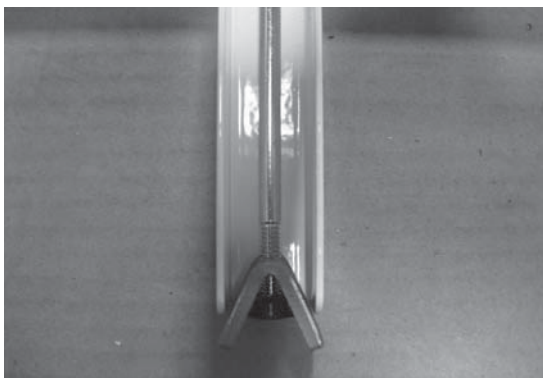

**Step 4:** Locate the parts from the following list if the unit was ordered with doors. If no doors were ordered, use four standard sides.

Part	Description	Quantity
#15	Side, Hinge / Hasp	2
#16	Side, Hinge	1
#17	Side, Hasp	1

## Side Orientation

If the unit was ordered with doors, the sides must be placed and oriented in the correct location, as shown below. If you were to flip this unit up on its casters you would be looking at the front view. Starting at the right side you have a side with only hinges, a side with a hasp and a hinge, another side with a hasp and hinge, and on the far left side, only a hasp. **There are holes on the bottom of each side that must line up with the holes in the base of the unit.**

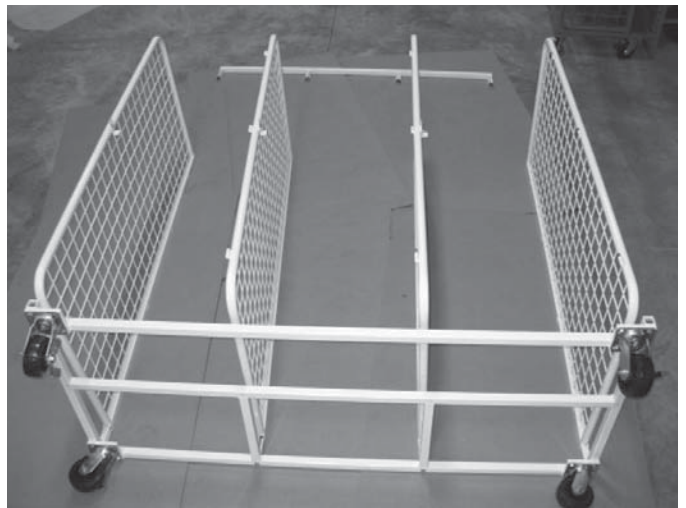

# Side and Back Panel Installation

## Side Installation

Start the sides in the orientation as shown in the previous photo and explanation. Move the sides over the U-channel on the base. Do not push the sides all the way down to the base at this point as shown in the photo below.



**Step 5:** Locate the parts from the following list:

Part	Description	Quantity
#12	Back Panel	3

## Back Panel Installation

To install the back panels, spread the sides apart just enough to place the back panels in. Line up the long wires to mate with the holes in the side tube as shown in the photos below. Place all three panels in at this time. The Gear Grid label should face the inside of unit at the top.

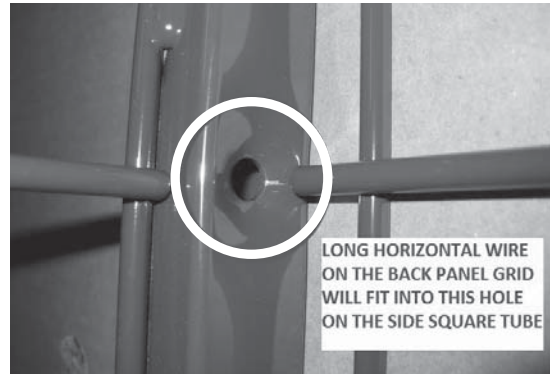
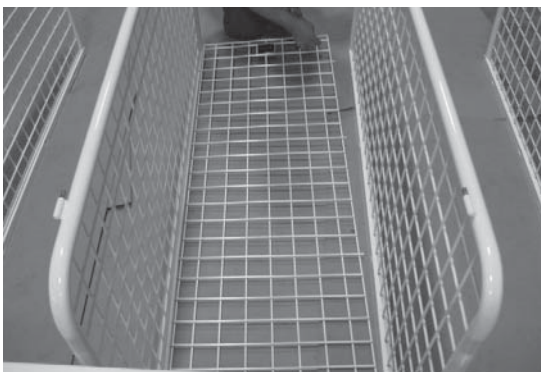

**Step 6:** Locate the following parts from the list:

Part	Description	Quantity
#18	Top	3

To install the tops, use the same method as in step 5. Line up the long wires with the holes in the side tubes and place into position as shown in the photo below.



## Side and Back Panel Installation (cont.)

**Step 7:** Install the assembled 3-start to the top of the unit with the U-channels inserted down through the side tubes as shown in the photo below.



**Step 8:** Push the side panels onto the base so they sit all the way down. Push the 3-start all the way down onto the top of the side tubes. Now tighten the four bolts on the bottom of the base and the bolts on the 3-start. **Do not overtighten to avoid deformation of the material.**

**Step 9:** Locate the parts from the following list:

Part	Description	Quantity
#5	Screw, #14	4

Install four #14 screws through the base into the holes on the bottom of the sides as shown in the photo below.

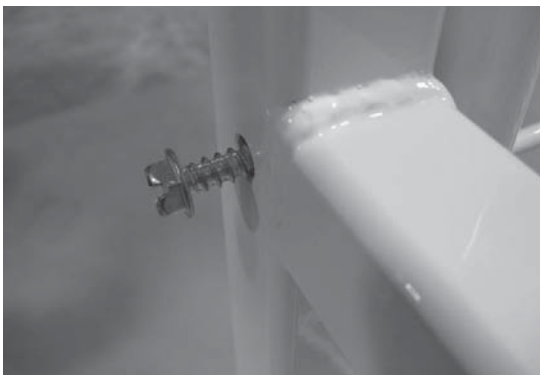

**Step 10:** Locate the parts from the following list:

Part	Description	Quantity
#19	Stainless Rod 1/4-20 x 73.75"	1
#9	1/4-20 Acorn Nut	2

Install stainless threaded rod through the tops, use two acorn nuts to tighten as shown in the photos below.

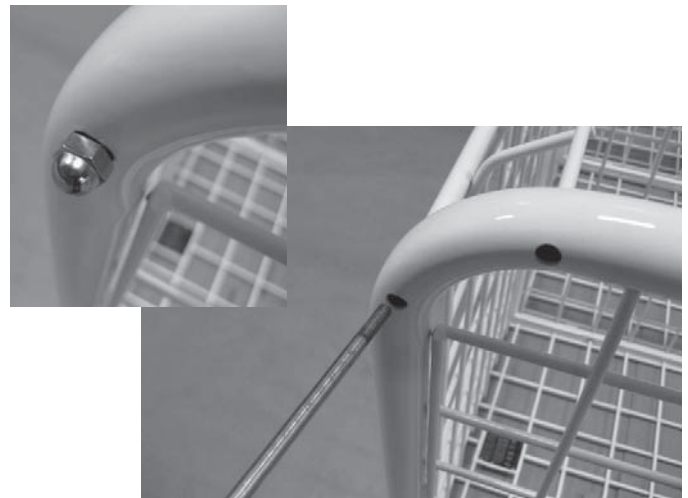

**Step 11:** Stand unit up on casters.

## Door Installation

**Step 1:** If the unit was ordered with doors, locate the following parts from the list:

Part	Description	Quantity
#22	Brass Bushing	9
#13	Door	3
#10	Door Latch Assembly	3
#8	1/4-20 x 3/8" Screw	6

Install brass bushings to all hinges on the sides as shown in the photo at right.

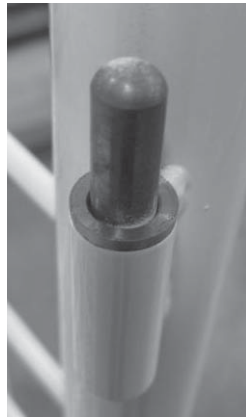

Install doors as shown in the photos below.



**Step 2:** Install the door latch assembly to the door using the screws noted above. Assemble the latch to the door loosely then close the door to position the latch. Tighten the screws as seen below.



## Custom Storage Accessories\*

\*Applicable if you ordered these accessories.

### Accessory Part List

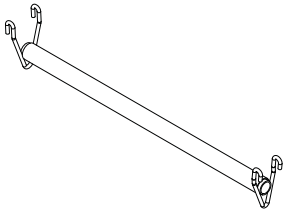

HANGING ROD  
QTY - PER ORDER

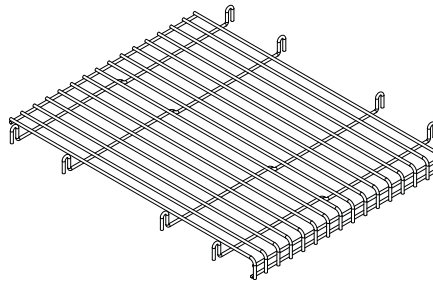

FLAT SHELF  
QTY - PER ORDER

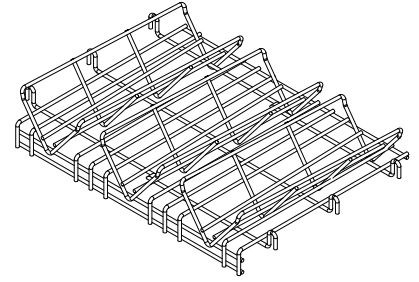

BOTTLE SHELF  
QTY - PER ORDER

### Shelf Installation

Install the shelf into unit as shown in the photos below. The hooks on the shelves get placed over the horizontal wires on the side panels. The left side hook will be placed behind the first vertical side panel wire. The right side shelf hook will be placed in front of the first vertical wire.

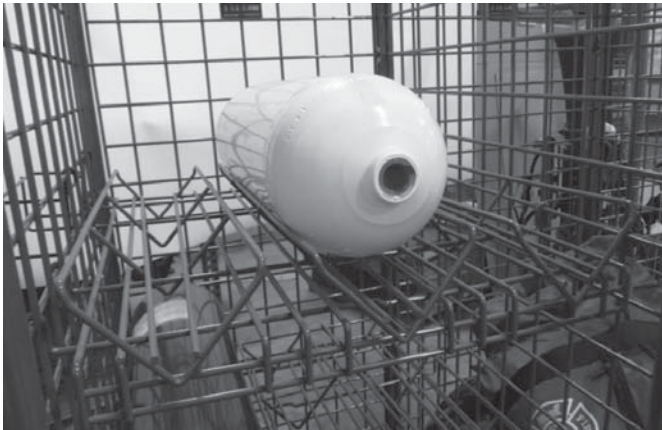

# Hang Bar Kit Installation

**Step 1:** Locate the following parts:



HANG BAR  
QTY - 1

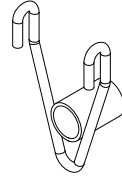

HANG BAR BRACKET  
2.25 SPREAD  
QTY - 1

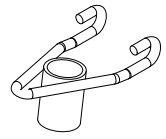

HANG BAR BRACKET  
1.625 SPREAD  
QTY - 1

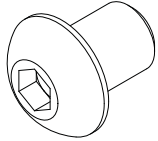

1/4-20 x 1" SCREW  
QTY - 2

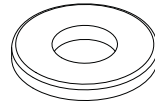

1/4" WASHER  
QTY - 4



1/4-20 NUT  
QTY - 2

**Step 2:** Position hang bar as shown in the photos below.

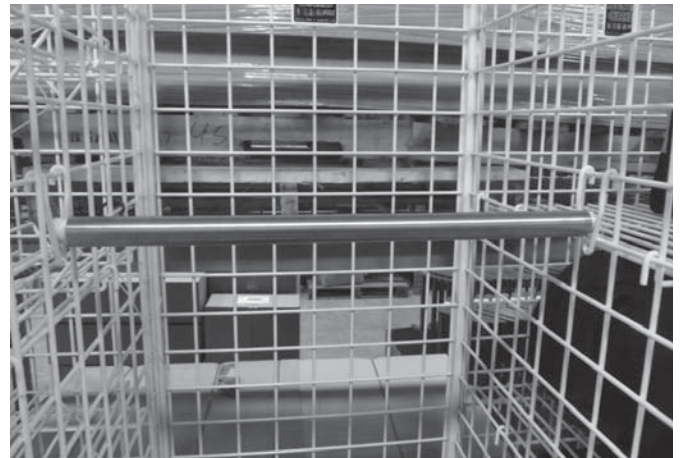

**Step 3:** Insert screw and washer through bracket and place a washer and nut on the other side to secure bracket as shown in the photo below. Repeat for the other bracket.



## Warranty

---

GEARGRID Wall Mount Lockers are guaranteed to be free of material and workmanship defects for one full year from the date of purchase.

GEARGRID guarantees to repair or replace defective materials, without charge. To file a claim call our Customer Service department at 888-643-6694. If product return is necessary your Customer Service representative will authorize the return and make arrangements to replace the defective parts.

This is your sole GEARGRID warranty. GEARGRID disclaims all other warranties, including the warranty of merchantability and fitness for a particular purpose, as well as all liability for incidental, consequential, special and indirect damage. GEARGRID liability shall be limited to the amount you paid for the product under warranty. GEARGRID reserves the right to make product changes without obligation to incorporate such changes into products previously sold.

Some states do not allow the exclusion or limitation of damages or warranties, so the above may not apply to you. This warranty gives you specific legal rights. You may also have other rights which may vary from state to state.

GEARGRID products are covered by U.S. patents: 6,241,107; D 636,202; D 635,810



670 SW 15th Street | Forest Lake, MN 55025  
Phone: 888-643-6694 | 651-464-4468  
Fax: 651-464-4780

